

Please circulate to

---

---

---

---

Quarterly Technical  
Newsletter of Australia's  
leading supplier of  
low-voltage motor control  
and switchgear.

## TAKING THE 'HISS' OUT OF DC SWITCHING

Selecting switchgear for DC applications requires careful attention to the electrical rating of the device. For low-voltage applications, electrical equipment has usually been designed for AC rating.

For DC rating the equipment is either modified or derated or both. To understand why DC applications are more demanding it is worth considering the fundamentals of an electric-arc.

This provides free electrons and ions which can provide the means for current flow if an electric field is applied. The free electrons and ions gain energy from the electric field and ionisation can be maintained providing a self-sustaining situation with a high conductivity path through the gas.

The arc is thus primarily an ionised gas, or plasma with the electrons carrying most of the electrical current because of their low mass and

high mobility. If the current is constant, an equilibrium is established between ionising and recombination collisions resulting in a constant level of ionisation and hence constant conductance and arc-voltage.

If the current is increased, then more electrons are emitted from the cathode and an increase in ionising collision frequency occurs, ionisation increases, conductivity increases

### IN THIS ISSUE

- 1. Arc fundamentals **1**
- 2. Arc initiation **2**
- 3. Extinguishing the arc **3**
- 4. Series connection **4**
- 5. Other considerations **4**
- 6. Conclusion **4**

### 1. Arc fundamentals

The electric-arc is an electrical discharge and can only take place in a gaseous environment. The gas has to be extremely hot to conduct as it is normally a very poor conductor. High temperatures cause ionisation due to thermal agitation of neutral atoms.

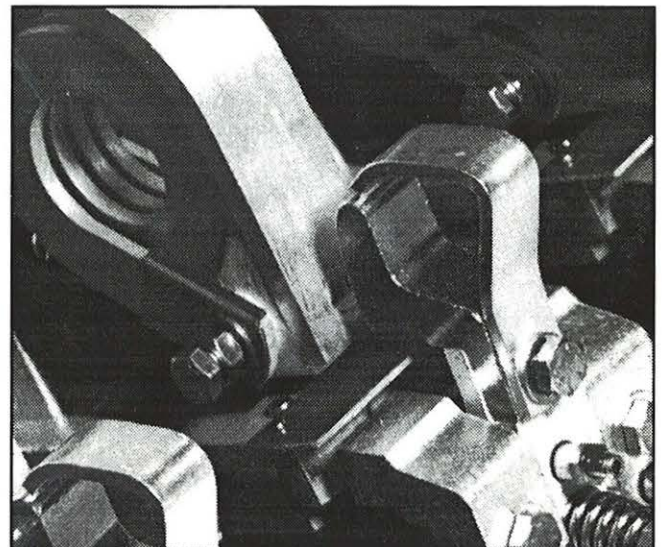

## 1. Arc fundamentals (continued from page 1)

and the arc-voltage drops. If the current decreases then the level of ionisation drops, conductivity decreases and arc-voltage increases. If the current decreases sufficiently a point will be reached where the arc-voltage approaches that available source of supply and the arc will self extinguish.

**Figure 1** shows the arc-voltage variation with the current for different arc lengths.

If we measure the voltage variation along an arc from the cathode to anode the result would be as shown in **figure 2**.

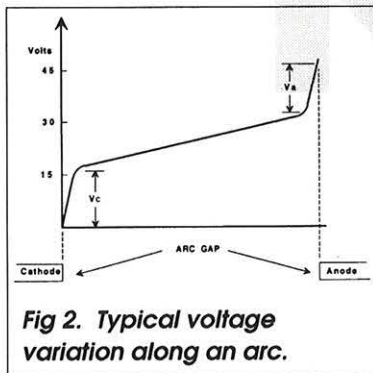

**Fig 2. Typical voltage variation along an arc.**

The voltage distribution has three distinct regions. (Near each electrode there are regions where the electrode gradient is very high). These are (1) the cathode and (2) anode falls and in practice the width of these may be only a fraction of a millimetre. In simple terms they represent the space charge set up at each electrode by the complex process whereby current flow changes from metallic to gaseous conduction. The sum of  $V_c$  and  $V_a$  is typically in the range of 15 to 30 volts, depending on the electrode material.

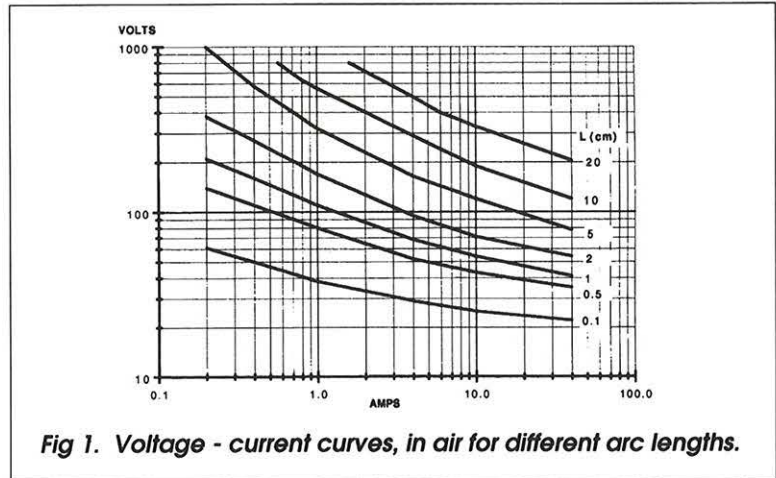

**Fig 1. Voltage - current curves, in air for different arc lengths.**

(3) The other region is the arc-column, characterised by a much lower and uniform electric field. If the arc length changes then it is the column which extends or contracts to accommodate the change, and it is the column voltage which varies.

## 2. Arc initiation

As explained above heat is an important input for an arc to be established. In the case of a switch opening, the loss of contact pressure just at the point of separation causes a dramatic increase in resistance resulting in rapid heating which provides ideal conditions for the arc.

The other point to be noted is the effect of the circuit inductance on the voltage between the contacts. Consider the simple circuit below:

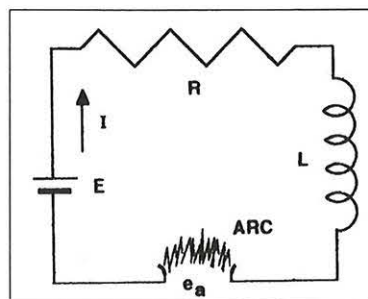

At any instant the following equation applies:

$$e_a = (E - Ri) - L \frac{di}{dt}$$

where

$(-L \frac{di}{dt})$  is the voltage

generated by the inductance to oppose the current variation.

The energy in the inductance must be dissipated and the voltage across the contacts increases to a level which ensures conduction (arcing) across the contact gap. This release of the stored energy in the circuit causes extra heating and erosion of the contacts.

As the inductance of the circuit increases it is normal to decrease the rating of the contact to take account of this problem.

DC circuits are referred to by their time constant which is the ratio of the inductance to the resistance or  $L/R$ . The larger the time constant the greater the electromagnetic energy of the circuit.

## 3. Extinguishing the arc

In AC circuits the current cycles through zero. This allows the air to cool sufficiently for the arc not to restrike. In the DC circuit the arc length must be increased to the point where the arc cannot be maintained.

The simplest way to do this is to have sufficient contact travel, but if high currents and/or voltages are to be interrupted it becomes impractical to provide the required gap. Additional features are required to extend and cool the arc.

### Magnetic "Blow-Out"

Because an arc is composed of ions and electrons the arc is affected by any magnetic field. The resulting effect is exactly the same as in the case of a conductor carrying current in the presence of a magnetic field in that a force is exerted on the conductor. In the case of the arc however it is effectively under no constraints as far as its movement is concerned. This can be used to advantage by designing a magnet system which will directly drive the arc away from the contacts.

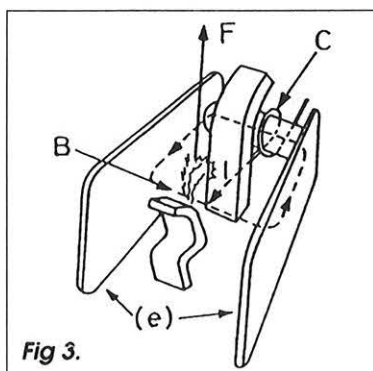

In figure 3 a common means of creating a suitable field is shown. The current flows into the blow out coil "C" that produces the flux in the magnetic circuit consisting of the core "N" and yokes "E". In the space where the contacts move the magnetic field and the arcs are perpendicular, the coil winding sense is such that the force "blows" the arc towards the area where, due to the contact's shape the distance is greater. Normally, this area is located towards the top or near the exhaust opening of the arc chamber, so that the action of the exhaust gases is in accordance with the natural movement of an arc produced by the thermal effect.

If the direction of the current is reversed, the induced force (produced by the current itself) is reversed as well and then the force remains oriented to the same direction. Therefore, reversing the polarity of the contactor connections does not harm the action of the magnetic blow-out. This is not true when the magnetic field is produced by permanent magnets as in some types of contactors, polarity must be observed.

The force produced by the magnetic blow-out, ie. its efficiency, is proportional to the square of the current.

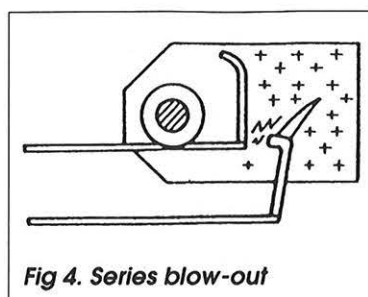

At low currents and higher voltages it can become difficult to extinguish the arc. To compensate for low currents the number of turns can be increased in the coil but the current carrying capacity of a coil in series with the main current path restricts the turns to a low number (see figure 4).

The problem can be overcome by providing a combined series coil and permanent magnet. As the current to be interrupted increases the coil provides additional force while for the low currents the magnet provides a constant field of adequate strength (see figure 5).

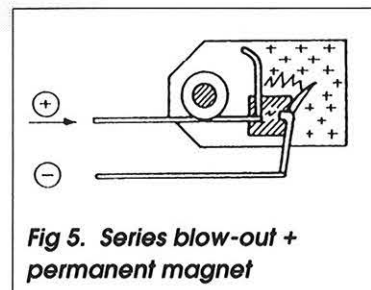

A solution that is sometimes applied to enable the turns in the blow-out coil to be increased is to arrange the coil in parallel. The coil is switched into the circuit by a late opening arcing contact. In this arrangement the coil only carries current for a short time and the conductor size can be greatly reduced (see figure 6).

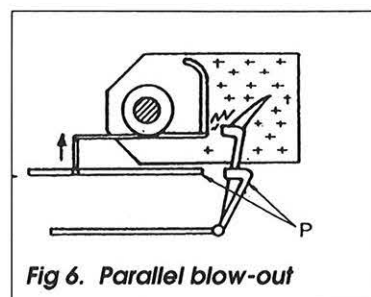

# 4

## 4. Series connection

It is common to use equipment designed for AC applications for DC systems. For double-break contact systems the DC rating will be similar to the AC rating, up to about 60 volts, but above this the rating needs to be decreased substantially. The AC design relies on the current passing through zero to extinguish the arc but this of course is not available in DC systems. Improved performance can be derived by connecting poles in a series. This increases the voltage that can be switched in direct proportion to the number of poles. It is therefore practical to cover DC applications up to 240 volt with AC designs.

## 5. Other considerations

The switching of DC may cause metal deposition to occur (figure 7) and this can cause failure of the system.

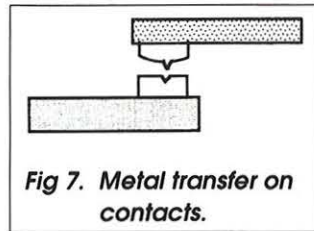

The metal spike produced can melt because of the high current concentration and result in a weld as the metal cools. If this weld is strong enough it can prevent the contacts from opening.

With small relays, when switching DC at high operational rates, it is wise to prove the system by testing it before committing to a particular design.

The selection of contact material can be critical in some applications. Silver is the common base material for contact systems but in plants where sulfur or chlorine is present it may be unsuitable. The formation of silver sulphide is extremely detrimental to the contact as it causes very high contact resistance.

In the case of very low voltages and currents,

gold is the preferred contact material as it is less prone to atmospheric attack and therefore produces a more stable contact resistance.

The actual contact resistance varies with each closure of a contact system. This is caused by the slight differences that arise in the alignment as well as solid contaminants such as dust moving in and out of the mating surface. The use of bifurcated or dual contacts improves the reliability considerably.

## 6. Conclusion

The switching of DC requires careful selection of the switching device. The most likely result of poor selection is that the arc will not be extinguished (an audible 'hiss' is produced) and this will result in major damage to the contact.

Consult the manufacturers guides and do not exceed these. If possible prove any highly repetitive switching applications by test if the application is part of a design to be reproduced many times.

**Contact NHP for all your  
switchgear requirements  
from the one source**

**NHP Electrical  
Engineering Products  
Pty Ltd** A.C.N. 004 304 812

### Melbourne

43 - 67 River Street,  
Richmond VIC. 3121

Phone: (03) 9429 2999

Fax: (03) 9429 1075

### Sydney

30 - 34 Day Street North,  
Silverwater N.S.W. 2141

Phone: (02) 748 3444

Fax: (02) 648 4353

### Brisbane

25 Turbo Drive,  
Coorparoo QLD. 4151

Phone: (07) 3891 6008

Fax: (07) 3891 6139

### Adelaide

50 Croydon Road,  
Keswick S.A. 5035

Phone: (08) 297 9055

Fax: (08) 371 0962

### Perth

38 - 42 Railway Parade,  
Bayswater W.A. 6053

Phone: (09) 271 8666

Fax: (09) 272 3906

### Newcastle

57 Crescent Road,  
Waratah N.S.W. 2298

Phone: (049) 60 2220

Fax: (049) 60 2203

### Townsville

62 Leyland Street,  
Garbutt QLD. 4814

Phone: (077) 79 0700

Fax: (077) 75 1457

### Rockhampton

208 Denison Street,  
Rockhampton QLD. 4700

Phone: (079) 27 2277

Fax: (079) 22 2947

### Toowoomba

Cnr Carroll Street &  
Struan Court,  
Toowoomba QLD. 4350

Phone: (076) 34 4799

Fax: (076) 33 1796

### Agents

#### Hobart

H. M. Bamford (Hobart)  
199 Harrington Street,  
Hobart TAS. 7000

Phone: (002) 34 9299

Fax: (002) 31 1693

#### Launceston

H. M. Bamford (Launceston)  
59 Garfield Street,  
Launceston TAS. 7250

Phone: (003) 44 8811

Fax: (003) 44 4069

#### Darwin

J. Blackwood & Son Ltd  
Mataram Street,  
Winnellie N.T. 0820

Phone: (089) 84 4255

Fax: (089) 84 3945

**NHP**  
*Proudly Australian*

Editorial content: - Please address all enquiries to 'The Editor' - 'NHP Technical News'  
PO Box 199, Richmond Victoria 3121.